

MAAP - Mini Architectural Adapter Plates

Passive MAAPs with Audio, Video, Phone, Data, Power, and Control Connectors

MAAP - MINI ARCHITECTURAL ADAPTER PLATES

Extron MAAP - Mini Architectural Adapter Plates are optional mounting plates designed to work with our installation interfaces, installation distribution amplifiers, wall plates, floor plates, rack plates, and other products that feature MAAP openings. Over 120 different MAAPs are available featuring popular video, audio, phone, data, computer, and control connectors. There are also MAAPs available with engraved labels of the most common pass-through connections and blank MAAPs to fill empty slots.

Custom engraving is available for an additional charge. See page 205.



Standard MAAPs



Engraved MAAPs

Video MAAPs

One BNC Female to Female Barrel

Type: Barrel/Adapter
Size: Single Space

COLOR	PART #
Black	70-286-11
White	70-286-21
RAL9010	70-286-51

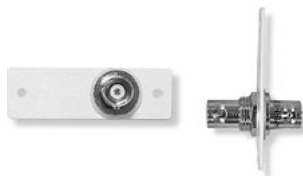

Same model with standard engraving

Engraving: "VIDEO"

COLOR	PART #
Black with Engraving	70-286-12
White with Engraving	70-286-22
RAL9010 White with Engraving	70-286-52



Two BNC Female to Female Barrels

Type: Pass-Through
Size: Single Space

COLOR	PART #
Black	70-286-13
White	70-286-23
RAL9010 White	70-286-53



Three BNC Female to Female Barrels

Type: Barrel/Adapter
Size: Double Space

COLOR	PART #
Black	70-440-11
White	70-440-21
RAL9010 White	70-440-51

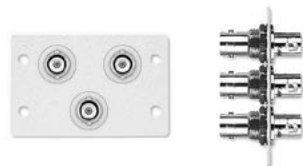

Video MAAPs

One S-Video Female to Female Barrel

Type: Barrel/Adapter
Size: Single Space

COLOR	PART #
Black	70-287-12
White	70-287-22
RAL9010 White	70-287-52



One S-Video Female to Bare Wires

Type: Installation
Size: Single Space

COLOR	PART #
Black	70-287-11
White	70-287-21
RAL9010 White	70-287-51



One S-Video Female to Two BNC Female on 4" Pigtails

Type: Quick Connect
Size: Single Space

COLOR	PART #
Black	70-287-14
White	70-287-24
RAL9010 White	70-287-54



One S-Video Female to Captive Screw Terminal

Type: Quick Connect
Size: Double Space

COLOR	PART #
Black	70-287-13
White	70-287-23
RAL9010 White	70-287-53



MAAP - Mini Architectural Adapter Plates (continued)

Passive MAAPs with Audio, Video, Phone, Data, Power, and Control Connectors

Video MAAPs

Two S-Video Female to Female Barrels

Type: Barrel/Adapter
Size: Single Space

COLOR	PART #
Black	70-287-15
White	70-287-25
RAL9010 White	70-287-55



Video MAAPs

One F-Connector Female to Female Barrel

Type: Barrel/Adapter
Size: Single Space

COLOR	PART #
Black	70-291-11
White	70-291-21
RAL9010 White	70-291-51



One S-Video Female to Female Barrel, One BNC Female to Female Barrel

Type: Barrel/Adapter
Size: Single Space

COLOR	PART #
Black	70-288-11
White	70-288-21
RAL9010 White	70-288-51



Two F-Connector Female to Female Barrels

Type: Barrel/Adapter
Size: Single Space

COLOR	PART #
Black	70-291-12
White	70-291-22
RAL9010 White	70-291-52



One RCA Female to Female Barrel – White

Type: Barrel/Adapter
Size: Single Space

COLOR	PART #
Black	70-289-11
White	70-289-21
RAL9010 White	70-289-51



One RCA Female to BNC Female Adapter

Type: Barrel/Adapter
Size: Single Space

COLOR	PART #
Black	70-290-11
White	70-290-21
RAL9010 White	70-290-51



Two RCA Female to BNC Female Adapters

Type: Barrel/Adapter
Size: Single Space

COLOR	PART #
Black	70-290-12
White	70-290-22
RAL9010 White	70-290-52



MAAP - Mini Architectural Adapter Plates (continued)

Passive MAAPs with Audio, Video, Phone, Data, Power, and Control Connectors

Audio/Video MAAPs

One BNC Female to Female Barrel, One 3.5 mm Stereo Mini Jack to Solder Tabs

Type: Barrel & Installation
Size: Single Space

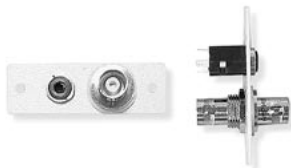

COLOR	PART #
Black	70-301-11
White	70-301-21
RAL9010 White	70-301-51

One BNC Female to Female Barrel, Two RCA Female to BNC Female Adapters

Type: Barrel/Adapter
Size: Double Space

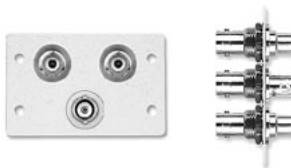

COLOR	PART #
Black	70-439-12
White	70-439-22
RAL9010 White	70-439-52

One S-Video Female to Female Barrel, One 3.5 mm Stereo Mini Jack to Solder Tabs

Type: Barrel & Installation
Size: Single Space



COLOR	PART #
Black	70-438-11
White	70-438-21
RAL9010 White	70-438-51

One S-Video Female to Bare Wire, One 3.5 mm Stereo Mini Jack to Solder Tabs

Type: Installation
Size: Single Space



COLOR	PART #
Black	70-302-11
White	70-302-21
RAL9010 White	70-302-51

One S-Video Female to Female Barrel, Two RCA Female to BNC Female Adapters

Type: Barrel/Adapter
Size: Double Space



COLOR	PART #
Black	70-443-12
White	70-443-22
RAL9010 White	70-443-52

Audio/Video MAAPs

One S-Video Female to Female Barrel, Two RCA Female to Female Barrels

Type: Barrel/Adapter
Size: Double Space

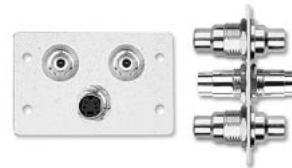

COLOR	PART #
Black	70-444-12
White	70-444-22
RAL9010 White	70-444-52

One S-Video Female to Female Barrel, Three RCA Female to BNC Female Adapters

Type: Barrel/Adapter
Size: Double Space

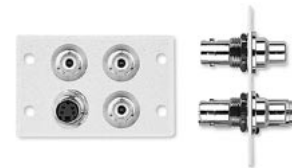

COLOR	PART #
Black	70-445-12
White	70-445-22
RAL9010 White	70-445-52

One S-Video Female to Female Barrel One RCA Female to BNC Female Adapter Two RCA Female to Female Barrels MAAP

Type: Barrel/Adapter
Size: Double Space



COLOR	PART #
Black	70-553-11
White	70-553-21
RAL9010 White	70-553-51

Same model with standard engraving

Engraving: "S-VIDEO", "VIDEO", "AUDIO", "L", "R"



COLOR	PART #
Black	70-553-12
White	70-553-22
RAL9010 White	70-553-52

One RCA Female to BNC Female Adapter, One 3.5 mm Stereo Mini Jack to Solder Tabs

Type: Adapter & Installation
Size: Single Space



COLOR	PART #
Black	70-436-11
White	70-436-21
RAL9010 White	70-436-51

MAAP - Mini Architectural Adapter Plates (continued)

Passive MAAPs with Audio, Video, Phone, Data, Power, and Control Connectors

Audio/Video MAAPs

One RCA Female to Female Barrel, One 3.5 mm Stereo Mini Jack to Solder Tabs

Type: Barrel & Installation
Size: Single Space

COLOR	PART #
Black	70-437-11
White	70-437-21
RAL9010 White	70-437-51



One RCA Female to Solder Cups – Video, Yellow; One 3.5 mm Stereo Mini Jack to Solder Tabs

Type: Installation
Size: Single Space

COLOR	PART #
Black	70-303-11
White	70-303-21
RAL9010 White	70-303-51



Two RCA Female to Solder Cups – Audio, Red/White; One RCA Female to Solder Cup – Video, Yellow

Type: Installation
Size: Single Space

COLOR	PART #
Black	70-300-11
White	70-300-21
RAL9010 White	70-300-51



Two RCA Female to Solder Cups – Audio, Red/White; One RCA Female to Solder Cup – Video, Yellow

Type: Installation
Size: Double Space

COLOR	PART #
Black	70-300-12
White	70-300-22
RAL9010 White	70-300-52



Audio/Video MAAPs

Three RCA Female to Female Barrels White/Red/Yellow

Type: Barrel/Adapter
Size: Double Space

COLOR	PART #
Black	70-289-13
White	70-289-23
RAL9010 White	70-289-53



Same model with standard engraving

Engraving: "LEFT", "RIGHT", "VIDEO"

COLOR	PART #
Black with Engraving	70-289-14
White with Engraving	70-289-24
RAL9010 White with Engraving	70-289-54



One RCA Female to BNC Female Adapter, Two RCA Female to Female Barrels

Type: Barrel/Adapter
Size: Double Space

COLOR	PART #
Black	70-442-12
White	70-442-22
RAL9010 White	70-442-52

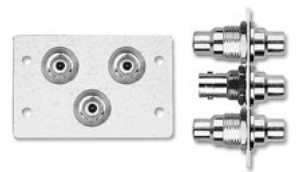

Two RCA Female to Captive Screw – Audio, Red/White; One RCA Female to Female Barrel – Video, Yellow

Type: Quick Connect
Size: Double Space

COLOR	PART #
Black	70-300-13
White	70-300-23
RAL9010 White	70-300-53



Same model with standard engraving

Engraving: "LEFT", "RIGHT", "VIDEO"

COLOR	PART #
Black with Engraving	70-300-14
White with Engraving	70-300-24
RAL9010 White with Engraving	70-300-54



MAAP - Mini Architectural Adapter Plates (continued)

Passive MAAPs with Audio, Video, Phone, Data, Power, and Control Connectors

Audio/Video MAAPs

A/V Super Module: Two RCA Female to Solder Cups – Audio, Red/White; One RCA Female to Solder Cups – Video, Yellow; One S-Video Female to Bare Wires

Type: Installation
Size: Double Space



COLOR	PART #
Black	70-299-11
White	70-299-21
RAL9010 White	70-299-51

A/V Super Module: Two RCA Female to Female Barrels – Audio, Red/White; One RCA Female to Female Barrel – Video, Yellow; One S-Video Female to Female Barrel

Type: Barrel/Adapter
Size: Double Space



COLOR	PART #
Black	70-299-12
White	70-299-22
RAL9010 White	70-299-52

Same model with standard engraving

Engraving: "S-VIDEO", "VIDEO", "LEFT", "RIGHT"



COLOR	PART #
Black with Engraving	70-299-13
White with Engraving	70-299-23
RAL9010 White with Engraving	70-299-53

A/V Super Module: Two RCA Female to Captive Screw - Audio, Red/White; One RCA Female to Female Barrel – Video, Yellow; One S-Video Female to Female Barrel

Type: Quick Connect
Size: Double Space



COLOR	PART #
Black	70-299-14
White	70-299-24
RAL9010 White	70-299-54

Audio MAAPs

One XLR 3-pin Male to Solder Cups - Switchcraft

Type: Installation
Size: Double Space

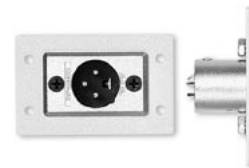

COLOR	PART #
Black	70-296-14
White	70-296-24
RAL9010 White	70-296-54

One XLR 3-pin Female to Solder Cups - Switchcraft

Type: Installation
Size: Double Space

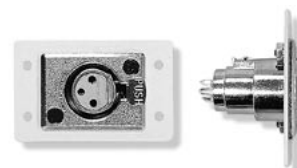

COLOR	PART #
Black	70-296-13
White	70-296-23
RAL9010 White	70-296-53

One XLR 3-pin Female to Solder Cups - Neutrik

Type: Installation
Size: Double Space



COLOR	PART #
Black	70-296-11
White	70-296-21
RAL9010 White	70-296-51

Same model with standard engraving

Engraving: "MICROPHONE"



COLOR	PART #
Black with Engraving	70-296-12
White with Engraving	70-296-22
RAL9010 White with Engraving	70-296-52

One XLR 3-pin Male to Solder Cups - Neutrik

Type: Installation
Size: Double Space



COLOR	PART #
Black	70-448-12
White	70-448-22
RAL9010 White	70-448-52

MAAP - Mini Architectural Adapter Plates (continued)

Passive MAAPs with Audio, Video, Phone, Data, Power, and Control Connectors

Audio MAAPs

One Mini XLR 3-pin Male to Solder Cups - Switchcraft

Type: Installation
Size: Single Space

COLOR	PART #
Black	70-297-11
White	70-297-21
RAL9010 White	70-297-51



One Mini XLR 3-pin Male to Captive Screw - Switchcraft

Type: Quick Connect
Size: Single Space

COLOR	PART #
Black	70-297-12
White	70-297-22
RAL9010 White	70-297-52



Two Mini XLR 3-pin Male to Solder Cups - Switchcraft

Type: Installation
Size: Single Space

COLOR	PART #
Black	70-297-13
White	70-297-23
RAL9010 White	70-297-53



Two RCA Female to Solder Cups—Red / White

Type: Installation
Size: Single Space

COLOR	PART #
Black	70-292-11
White	70-292-21
RAL9010 White	70-292-51



Same model with standard engraving

Engraving: "LEFT", "RIGHT"

COLOR	PART #
Black with Engraving	70-292-12
White with Engraving	70-292-22
RAL9010 White with Engraving	70-292-52



Audio MAAPs

Two RCA Female to Female Barrels—Red / White

Type: Barrel/Adapter
Size: Single Space

COLOR	PART #
Black	70-289-12
White	70-289-22
RAL9010 White	70-289-52



Two RCA Female to Captive Screw Terminal—Red / White

Type: Quick Connect
Size: Single Space

COLOR	PART #
Black	70-292-14
White	70-292-24
RAL9010 White	70-292-54



One 1/4" Stereo Phone Female to Solder Tabs

Type: Installation
Size: Single Space

COLOR	PART #
Black	70-295-11
White	70-295-21
RAL9010 White	70-295-51



One 1/4" Stereo Phone Female to Captive Screw Terminal

Type: Quick Connect
Size: Single Space

COLOR	PART #
Black	70-295-12
White	70-295-22
RAL9010 White	70-295-52



Two 1/4" Mono Phone Female to Solder Tabs

Type: Installation
Size: Single Space

COLOR	PART #
Black	70-326-11
White	70-326-21
RAL9010 White	70-326-51



MAAP - Mini Architectural Adapter Plates (continued)

Passive MAAPs with Audio, Video, Phone, Data, Power, and Control Connectors

Audio MAAPs

Two 1/4" Stereo Phone Female to Solder Tabs

Type: Installation
Size: Single Space



COLOR	PART #
Black	70-295-13
White	70-295-23
RAL9010 White	70-295-53

One 3.5 mm Stereo Mini Jack to Solder Tabs

Type: Installation
Size: Single Space



COLOR	PART #
Black	70-293-11
White	70-293-21
RAL9010 White	70-293-51

Same model with standard engraving

Engraving: "AUDIO"



COLOR	PART #
Black with Engraving	70-293-12
White with Engraving	70-293-22
RAL9010 White with Engraving	70-293-52

One 3.5 mm Stereo Mini Jack to Captive Screw Terminal

Type: Quick Connect
Size: Single Space



COLOR	PART #
Black	70-293-13
White	70-293-23
RAL9010 White	70-293-53

Two 3.5 mm Stereo Mini Jack to Solder Tabs

Type: Installation
Size: Single Space



COLOR	PART #
Black	70-293-14
White	70-293-24
RAL9010 White	70-293-54

Audio MAAPs

Two 3.5 mm Stereo Mini Jack to Captive Screw Terminal

Type: Quick Connect
Size: Single Space



COLOR	PART #
Black	70-293-15
White	70-293-25
RAL9010 White	70-293-55

One Contact Closure Switch - Momentary, Single Pole with LED - to Solder Tabs; One 3.5 mm Stereo Mini Jack to Solder Tabs

Type: Installation
Size: Single Space



COLOR	PART #
Black	70-294-11
White	70-294-21
RAL9010 White	70-294-51

One Contact Closure Switch - Momentary, Single Pole with LED - to Captive Screw; One 3.5 mm Stereo Mini Jack to Captive Screw

Type: Quick Connect
Size: Single Space



COLOR	PART #
Black	70-294-12
White	70-294-22
RAL9010 White	70-294-52

One Neutrik Speakon Male to Solder Tabs - 4 Pole

Type: Installation
Size: Double Space

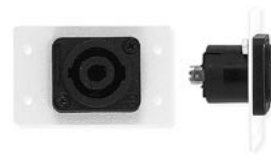

COLOR	PART #
Black	70-298-11
White	70-298-21
RAL9010 White	70-298-51

MAAP - Mini Architectural Adapter Plates (continued)

Passive MAAPs with Audio, Video, Phone, Data, Power, and Control Connectors

Control/Computer MAAPs

One 15-pin HD Female to Female Barrel

Type: Barrel/Adapter
Size: Single Space

COLOR	PART #
Black	70-309-11
White	70-309-21
RAL9010 White	70-309-51



Same model with standard engraving

Engraving: "COMPUTER VIDEO"

COLOR	PART #
Black with Engraving	70-309-12
White with Engraving	70-309-22
RAL9010 White with Engraving	70-309-52



One 15-pin HD Male to Male Barrel

Type: Barrel/Adapter
Size: Single Space

COLOR	PART #
Black	70-309-13
White	70-309-23
RAL9010 White	70-309-53



One 15-pin HD Female to Five BNC on 4" Pigtails

Type: Quick Connect
Size: Single Space

COLOR	PART #
Black	70-309-14
White	70-309-24
RAL9010 White	70-309-54



Control/Computer MAAPs

One 15-pin HD Female to Female Barrel, One 3.5 mm Stereo Mini Jack to Solder Cups

Type: Barrel & Installation
Size: Double Space

COLOR	PART #
Black	70-433-12
White	70-433-22
RAL9010 White	70-433-52



Same model with standard engraving

Engraving: "COMPUTER VIDEO"

COLOR	PART #
Black with Engraving	70-433-13
White with Engraving	70-433-23
RAL9010 White with Engraving	70-433-53



One 9-pin D Female to Female Barrel

Type: Barrel/Adapter
Size: Single Space

COLOR	PART #
Black	70-310-11
White	70-310-21
RAL9010 White	70-310-51



One 9-pin D Male to Male Barrel

Type: Barrel/Adapter
Size: Single Space

COLOR	PART #
Black	70-310-12
White	70-310-22
RAL9010 White	70-310-52



One 9-pin D Female to Female Barrel, One 3.5 mm Stereo Mini Jack to Solder Cups

Type: Barrel & Installation
Size: Double Space

COLOR	PART #
Black	70-434-11
White	70-434-21
RAL9010 White	70-434-51



MAAP - Mini Architectural Adapter Plates (continued)

Passive MAAPs with Audio, Video, Phone, Data, Power, and Control Connectors

Control/Computer MAAPs

One 6-pin Mini DIN Female to Bare Wires—Keyboard/Mouse

Type: Installation
Size: Single Space

COLOR	PART #
Black	70-311-11
White	70-311-21
RAL9010 White	70-311-51



One 6-pin Mini DIN Female to Female Barrel—Keyboard/Mouse

Type: Barrel/Adapter
Size: Single Space

COLOR	PART #
Black	70-311-12
White	70-311-22
RAL9010 White	70-311-52



Two 6-pin Mini DIN Female to Bare Wires—Keyboard/Mouse

Type: Installation
Size: Single Space

COLOR	PART #
Black	70-311-13
White	70-311-23
RAL9010 White	70-311-53



Two 6-pin Mini DIN Female to Female Barrels—Keyboard/Mouse

Type: Barrel/Adapter
Size: Single Space

COLOR	PART #
Black	70-311-14
White	70-311-24
RAL9010	70-311-54



One Crestron TPSBLOCK-10 Panel Mount Interface for Crestnet touch panel

Type: Installation
Size: Single Space

COLOR	PART #
Black	70-319-11
White	70-319-21
RAL9010	70-319-51



Note: TPSBLOCK-10 not included and must be ordered separately.

Control/Computer MAAPs

One USB A Female to USB B Female Adapter

Type: Barrel/Adapter
Size: Single Space

COLOR	PART #
Black	70-383-11
White	70-383-21
RAL9010 White	70-383-51



One USB A Female to Female Barrel

Type: Barrel/Adapter
Size: Double Space

COLOR	PART #
Black	70-455-11
White	70-455-21
RAL9010 White	70-455-51



One USB B Female to Female Barrel

Type: Barrel/Adapter
Size: Single Space

COLOR	PART #
Black	70-457-11
White	70-457-21
RAL9010 White	70-457-51



One USB B Female to USB A Female Adapter

Type: Barrel/Adapter
Size: Single Space

COLOR	PART #
Black	70-459-11
White	70-459-21
RAL9010 White	70-459-51



One USB Connector to Captive Screw

Type: Quick Connect
Size: Single Space

COLOR	PART #
Black	70-312-11
White	70-312-21
RAL9010 White	70-312-51

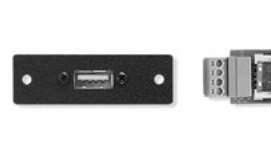

MAAP - Mini Architectural Adapter Plates (continued)

Passive MAAPs with Audio, Video, Phone, Data, Power, and Control Connectors

Control/Computer MAAPs

One XLR 4-pin Female to Solder Cups - Neutrik

Type: Installation
Size: Double Space

COLOR	PART #
Black	70-305-11
White	70-305-21
RAL9010 White	70-305-51

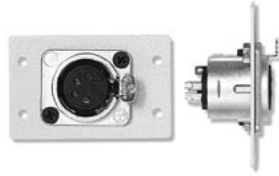

One XLR 4-pin Female to Solder Cups - Switchcraft

Type: Installation
Size: Double Space

COLOR	PART #
Black	70-305-12
White	70-305-22
RAL9010 White	70-305-52

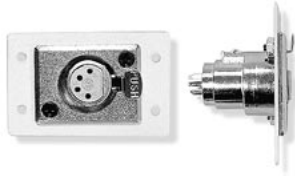

One XLR 5-pin Female to Solder Cups - Neutrik

Type: Installation
Size: Double Space

COLOR	PART #
Black	70-305-13
White	70-305-23
RAL9010 White	70-305-53



One XLR 6-pin Female to Solder Cups - Neutrik

Type: Installation
Size: Double Space

COLOR	PART #
Black	70-305-14
White	70-305-24
RAL9010	70-305-54



One XLR 6-pin Female to Solder Cups - Switchcraft

Type: Installation
Size: Double Space

COLOR	PART #
Black	70-305-15
White	70-305-25
RAL9010 White	70-305-55

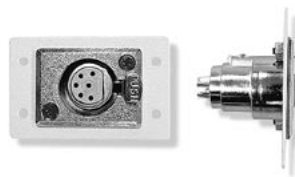

Control/Computer MAAPs

One XLR 7-pin Female to Solder Cups - Switchcraft

Type: Installation
Size: Double Space

COLOR	PART #
Black	70-305-16
White	70-305-26
RAL9010 White	70-305-56



One Mini XLR 4-pin Male to Solder Cups - Switchcraft

Type: Installation
Size: Single Space

COLOR	PART #
Black	70-307-11
White	70-307-21
RAL9010 White	70-307-51



One Mini XLR 4-pin Male to Captive Screw Terminal - Switchcraft

Type: Quick Connect
Size: Single Space

COLOR	PART #
Black	70-307-12
White	70-307-22
RAL9010 White	70-307-52



One Mini XLR 6-pin Male to Solder Cups - Switchcraft

Type: Installation
Size: Single Space

COLOR	PART #
Black	70-307-13
White	70-307-23
RAL9010 White	70-307-53



MMX 32 MAAP

Single-space MAAP for remote control of one output on an MMX 32 VGA Series Matrix Switcher.

Type: Installation
Size: Single Space

COLOR	PART #
Black	70-277-12
White	70-277-22
RAL9010 White	70-277-52

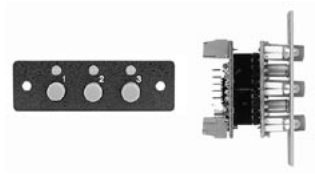

MAAP - Mini Architectural Adapter Plates (continued)

Passive MAAPs with Audio, Video, Phone, Data, Power, and Control Connectors

Control/Computer MAAPs

One 5-pin Captive Screw Terminal to Solder Tabs

Type: Installation
Size: Single Space



COLOR	PART #
Black	70-308-11
White	70-308-21
RAL9010 White	70-308-51

One Contact Closure Switch - Momentary, Single Pole with LED - to Solder Tabs; One 3.5 mm Stereo Mini Jack to Solder Tabs

Type: Installation
Size: Single Space



COLOR	PART #
Black	70-294-11
White	70-294-21
RAL9010 White	70-294-51

One Contact Closure Switch - Momentary, Single Pole with LED - to Captive Screw; One 3.5 mm Stereo Mini Jack to Captive Screw

Type: Quick Connect
Size: Single Space



COLOR	PART #
Black	70-294-12
White	70-294-22
RAL9010 White	70-294-52

One Switch: Latching, Single Pole, Single Throw, 10A / 125 VAC, 6A / 250 VAC Max Voltage

Type: Installation
Size: Single Space



COLOR	PART #
Black	70-304-11
White	70-304-21
RAL9010 White	70-304-51

One Switch with Integral LED: Latching, Single Pole, Single Throw, 5A / 125 VAC, 3A / 250VAC Max Voltage

Type: Installation
Size: Single Space



COLOR	PART #
Black	70-304-12
White	70-304-22
RAL9010 White	70-304-52

Control/Computer MAAPs

One Switch: Latching, Single Pole, Double Throw, 15A / 125 VAC, 10A / 250 VAC, 10A / 28 VDC Max Voltage

Type: Installation
Size: Single Space



COLOR	PART #
Black	70-304-13
White	70-304-23
RAL9010 White	70-304-53

One Switch: Latching, Double Pole, Double Throw, 15A / 125 VAC, 10A / 250 VAC, 10A / 28 VDC Max Voltage

Type: Installation
Size: Double Space

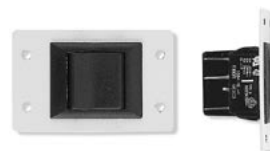

COLOR	PART #
Black	70-304-14
White	70-304-24
RAL9010 White	70-304-54

MAAP - Mini Architectural Adapter Plates (continued)

Passive MAAPs with Audio, Video, Phone, Data, Power, and Control Connectors

Data/Phone MAAPs

One Fiber ST Female to Female Barrel

Type: Barrel/Adapter
Size: Double Space

COLOR	PART #
Black	70-467-11
White	70-467-21
RAL9010 White	70-467-51



One Fiber SC Female to Female Barrel

Type: Barrel/Adapter
Size: Double Space

COLOR	PART #
Black	70-468-11
White	70-468-21
RAL9010 White	70-468-51



One Fiber MTRJ Female to Female Barrel

Type: Barrel/Adapter
Size: Double Space

COLOR	PART #
Black	70-469-11
White	70-469-21
RAL9010 White	70-469-51



One Fiber Duplex LC Female to Female Barrel

Type: Barrel/Adapter
Size: Double Space

COLOR	PART #
Black	70-470-11
White	70-470-21
RAL9010 White	70-470-51



One RJ-11 Female to Punch Down Block – Phone

Type: Installation
Size: Single Space

COLOR	PART #
Black	70-313-11
White	70-313-21
RAL9010 White	70-313-51



Data/Phone MAAPs

One RJ-11 Female to Punch Down Block – Phone

Type: Installation
Size: Double Space

COLOR	PART #
Black	70-313-13
White	70-313-23
RAL9010 White	70-313-53

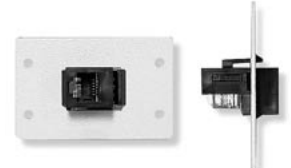

One RJ-11 Female to Female Barrel – Phone

Type: Barrel/Adapter
Size: Single Space

COLOR	PART #
Black	70-313-12
White	70-313-22
RAL9010 White	70-313-52



One RJ-11 Female to Punch Down Block – Phone

Type: Installation
Size: Double Space

COLOR	PART #
Black	70-319-14
White	70-319-24
RAL9010 White	70-319-54

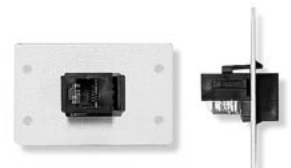

One RJ-45 Female to Punch Down Block – Data

Type: Installation
Size: Single Space

COLOR	PART #
Black	70-314-11
White	70-314-21
RAL9010 White	70-314-51



Same model with standard engraving

Engraving: "NETWORK"

COLOR	PART #
Black with Engraving	70-314-12
White with Engraving	70-314-22
RAL9010 White with Engraving	70-314-52



MAAP - Mini Architectural Adapter Plates (continued)

Passive MAAPs with Audio, Video, Phone, Data, Power, and Control Connectors

Data/Phone MAAPs

One RJ-45 Female to Punch Down Block— Data

Type: Installation
Size: Double Space

COLOR	PART #
Black	70-314-15
White	70-314-25
RAL9010 White	70-314-55

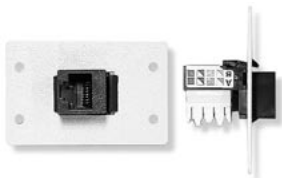

Data/Phone MAAPs

One RJ-45 Female to Punch Down for CAT6 – Leviton XCS Series

Type: Installation
Size: Double Space

COLOR	PART #
Black	70-314-18
White	70-314-28
RAL9010 White	70-314-58

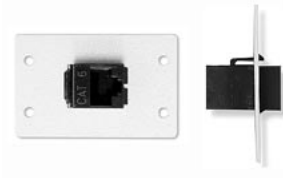

One RJ-45 Female to Female Barrel – Data

Type: Barrel/Adapter
Size: Single Space

COLOR	PART #
Black	70-314-13
White	70-314-23
RAL9010 White	70-314-53



One RJ-45 Female – Neutrik EtherCon Ruggedized Connector to Punch Down Block

Type: Installation
Size: Double Space

COLOR	PART #
Black	70-314-19
White	70-314-29
RAL9010 White	70-314-59

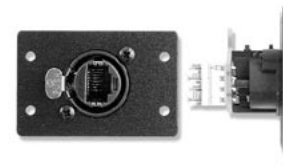

Same model with standard engraving

Engraving: "NETWORK"

COLOR	PART #
Black with Engraving	70-314-14
White with Engraving	70-314-24
RAL9010 White with Engraving	70-314-54



One RJ-45 Female to Female Barrel – Data

Type: Barrel/Adapter
Size: Double Space

COLOR	PART #
Black	70-314-16
White	70-314-26
RAL9010 White	70-314-56

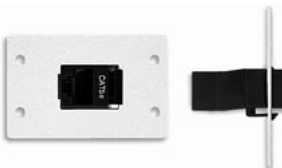

One RJ-45 Female to Punch Down for CAT6 – Leviton XCS Series

Type: Installation
Size: Single Space

COLOR	PART #
Black	70-314-17
White	70-314-27
RAL9010 White	70-314-57



MAAP - Mini Architectural Adapter Plates (continued)

Passive MAAPs with Audio, Video, Phone, Data, Power, and Control Connectors

Blank Plates

Blank Plate-Single

Size:

COLOR	PART #
Black	70-315-11
White	70-315-21
RAL9010 White	70-315-51



Blank Plate-Double

Size: Double Space

COLOR	PART #
Black	70-315-12
White	70-315-22
RAL9010 White	70-315-52

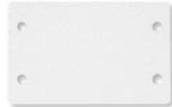

Blank Plate-Triple

Size: Triple Space

COLOR	PART #
Black	70-315-13
White	70-315-23
RAL9010 White	70-315-53



Blank Plate-Quad

Size: Quad Space

COLOR	PART #
Black	70-315-14
White	70-315-24
RAL9010 White	70-315-54



One Grommet -1" ID

Type:

Size: Quad Space

COLOR	PART #
Black	70-316-11
White	70-316-21



Captive Cable Kits for CPM 200 / CPM 208



CMP 200 example

Captive Cable Kit with One Large Cable Hole

Type: Captive Cable
Size: Double Space

COLOR	PART #
Black	70-317-11
White	70-317-21

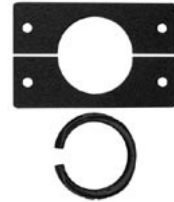

Captive Cable Kit with Two Small Cable Holes

Type: Captive Cable
Size: Double Space

COLOR	PART #
Black	70-317-12
White	70-317-22

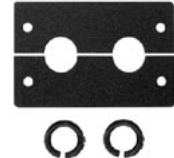

Captive Cable Kit with One Large Cable Hole and Two Small Cable Holes

Type: Captive Cable
Size: Triple Space

COLOR	PART #
Black	70-317-13
White	70-317-23

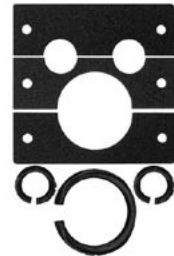

MAAP - Mini Architectural Adapter Plates (continued)

Passive MAAPs with Audio, Video, Phone, Data, Power, and Control Connectors

CTL208CM

Eight Button Control Module With Serial Output

DESCRIPTION

The Extron **CTL208CM** is an eight button control module that allows RS-232/422/485 serial commands to be sent with the touch of a button. This product installs in CPM Series modular connector frames, architectural interfaces or other products that accept a quad space MAAP. Custom engraving is available to label the button functions for an extra charge.

The CTL208CM utilizes the included ICS100 Control Software for simplified setup. Each button can be easily programmed to one of four operating modes: single - default, toggle, press/release, or continuous. Single mode sends the primary command code when the button is pressed. Toggle mode allows for the primary command code to be sent on the first press and a second command code to be sent when the button is pressed again. Press/release mode sends a command code when the button is pressed and sends a secondary command code when it is released. Continuous mode repeatedly sends the primary command code as long as the button is pressed. Individual LEDs next to each button illuminate when a button is selected.

An external international power supply is included, part # 70-055-01.

Button Groups

Available only for buttons that are assigned to the Toggle Mode, Button Groups allow buttons to be assigned to Group 1 or Group 2. Once assigned to a group, buttons operate in a mutually exclusive fashion - when one button is selected, others are deselected.

Timeout Feature

When the Timeout feature is engaged for a button, the unit will automatically send out the secondary command code string for that button after selected number of minutes. The timeout value can be set for 0 to 255 minutes. Since the timeout feature can be used to automatically turn off a device within a certain time, this feature is useful for projectors, plasma displays, monitors or other equipment that accept a serial command for power on/power off.



MODEL	VERSION DESCRIPTION	PART #
CTL208CM	Black	60-576-10
CTL208CM	White	60-576-20
CTL208CM	RAL9010 White	60-576-50

VCM 100 MAAP

MAAP Volume and Mute Controller

DESCRIPTION

The Extron **VCM 100 MAAP** provides remote volume and mute control of Extron MPA Series audio amplifiers and the MLP 101 and MLP 101 AAP mic preamps. It features a continuous gain control for fine adjustment of volume, and a dual color, illuminated pushbutton for muting the audio. The VCM 100 MAAP can be mounted into any Extron product or mounting frame with a double-space MAAP - Mini Architectural Adapter Plate opening.



MODEL	VERSION DESCRIPTION	PART #
VCM 100 MAAP	Black	70-397-11
VCM 100 MAAP	White	70-397-21
VCM 100 MAAP	RAL9010 White	70-397-51

CUSTOM ENGRAVING SERVICES

Extron is pleased to offer custom engraving services for AAPs, MAAPs, Blank Control Modules, Contact Closure Remotes, and the CTL208CM 8-button serial control panel. You can use the engraving to clearly indicate signal type, input numbers, or any other labeling required to make signal connections clear and easy.

Engraving Specifications

- ✓ **Standard Letter Size –**
Single Line Text MAAPs, AAPs, CCRs,
CM-5BB, and CM-20BB:
 0.08" / 2 mm Tall
- ✓ **Standard Letter Size –**
Double Line Text MAAPs, AAPs, CCRs,
CM-5BB, and CM-20BB:
 0.07" / 1.8 mm Tall

- ✓ **Standard Letter Size –**
Single Line Text CTL208CM:
 0.1" / 2.5 mm Tall
- ✓ **Standard Letter Size –**
Double Line Text CTL208CM:
 0.08" / 2 mm Tall
- ✓ **Standard Font:**
 Gothic, a sans serif-style font.
 Engraving is all capital letters.
- ✓ **Engraving Color:**
 White: Black Engraving
 Black: White Engraving
- ✓ **Engraving Process:** Letters / Numbers / Symbols
 are laser engraved, then filled with color.



Order Information

To order engraving for any of the AAPs, MAAPs, Blank Control Modules, Contact Closure Remotes, or the CTL208CM please refer to the instructions below and on the Engraving Order Forms. You can copy the Engraving Order Forms from the catalog or download PDF versions of these forms from the Extron Web site at <http://www.extron.com/engraving>

Instructions For Custom Engraving Orders

1. Check the Module Size

Determine the size of the connector module that is to be engraved. If you are ordering engraving for single-space MAAPs, use the Single MAAP Engraving Order Form. For double-space MAAPs, use the Double MAAP Engraving Order Form. For all AAPs, use the AAP Engraving Order Form. There are separate engraving order forms for the CCR204, CCR306, CM-5BB, CM-20BB, and CTL208CM.

2. Specify Connector Module & Quantity

Completely fill in the information at the top of the Engraving Order Form. Be sure to include the purchase order number, the part number of the connector module to be engraved as well as the number of modules to receive identical engraving.

3. Fill in the Boxes

The Engraving Order Forms have a template with "X" marks showing where engraving can be located on the module. Fill in the boxes indicating the text

and location for the engraving. Each box will allow one of the following: a letter, a number, or a blank space. Any box that is left blank will not be engraved. Unless otherwise specified, Extron will left justify all engraving that is selected for the left side of the plate, and right justify engraving that is selected for the right side of the plate. The left and right justification creates a uniform look for the A/V modular plates once they are installed onto the mounting frame or faceplate.

Corner Engraving

Selected plates have boxes that should be used to indicate the letters, words, or numbers that are to be engraved. See form for reference and more info.

Center Engraving

Center engraving is only available for XLR, RJ-45, RJ-11 double size MAAPs, and all AAPs except single-space AAPs with three connectors.

The Top Center Header and Bottom Center Footer sections of the Double MAAP and AAP Forms each

contain eight boxes that may be used to indicate the letters, words, or numbers that are to be engraved.

4. Get Engraving Prices

For assistance with engraving prices, call Extron at: **714.491.1500** or **800.633.9876**.

5. Submit Your Engraving Order and Purchase Order

Submit one Engraving Order Form for every unique plate design and every module model ordered. If identical engraving is required on several modules, then submit only one order form for each model number ordered. Be sure to include a purchase order that specifically authorizes purchase of the Extron products as well as the engraving service charges.

Fax Submission

Fax the completed engraving order form(s) and your purchase order to Extron at: **714.491.1517**.

Engraving Samples



70-409-11



70-292-21



CM-5BB



70-299-22



CCR 204

SINGLE MAAP ENGRAVING ORDER FORM

Customize Your Installation with Your Own Engraved MAAP.

Simply photocopy this form, complete the information needed and fax with your purchase order. You may also download a PDF version of this form at www.extron.com/engraving. Feel free to call us for assistance.

MAAP ENGRAVING ORDER FORM — SINGLE PLATE

Company Name: _____
 Contact Name: _____
 Phone #: _____
 Fax #: _____
 MAAP Part #: _____
 Quantity: _____
 Customer PO #: _____

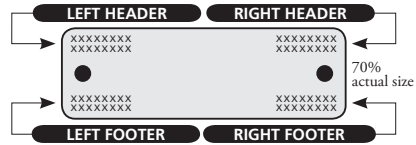

Note: Be sure to specify above the model of the MAAP to be engraved.

Engraved character size is .08"/2 mm high by 8 characters wide per line.

LEFT HEADER	RIGHT HEADER
1 ← Characters through → 8	1 ← Characters through → 8
9 ← Characters through → 16	9 ← Characters through → 16
LEFT FOOTER	RIGHT FOOTER
1 ← Characters through → 8	1 ← Characters through → 8
9 ← Characters through → 16	9 ← Characters through → 16

FAX COMPLETED FORM WITH YOUR ORDER TO: 714.491.1517

FOR EXTRON INTERNAL USE ONLY

EXTRON SO #: _____
 Engineering Reference #: _____
 Sales Representative: _____

CTL208CM ENGRAVING ORDER FORM

Simply photocopy this form, complete the information needed and fax with your purchase order. You may also download a PDF version of this form at www.extron.com/engraving. Feel free to call us for assistance.

CTL208CM FACEPLATE ENGRAVING ORDER FORM

Company Name: _____

Contact Name: _____

Phone #: _____

Fax #: _____

Part #: _____

Quantity: _____

Customer PO #: _____

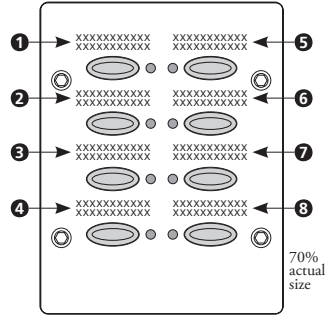

Engraved character size is .1"/2.5 mm high by 11 characters wide per line.

BUTTON 1

1 ← Characters through → 11

1 ← Characters through → 11

BUTTON 5

1 ← Characters through → 11

1 ← Characters through → 11

BUTTON 2

1 ← Characters through → 11

1 ← Characters through → 11

BUTTON 6

1 ← Characters through → 11

1 ← Characters through → 11

BUTTON 3

1 ← Characters through → 11

1 ← Characters through → 11

BUTTON 7

1 ← Characters through → 11

1 ← Characters through → 11

BUTTON 4

1 ← Characters through → 11

1 ← Characters through → 11

BUTTON 8

1 ← Characters through → 11

1 ← Characters through → 11

FAX COMPLETED FORM WITH YOUR ORDER TO: 714.491.1517

FOR EXTRON INTERNAL USE ONLY

EXTRON SO #: _____

Engineering Reference #: _____

Sales Representative: _____